

Nominal Size W x H x D (in)	Actual Size W x H x D (in)	Part Number	Capacity (CFM)	Resistance (in W.G.)	Media Area (sq ft)	Carton Qty	Weight per Carton (lbs)
24x24x4	23-3/8 x 23-3/8 x 3-3/4	120-721-001	2000	0.72	120	3	20
20x24x4	19-3/8 x 23-3/8 x 3-3/4	120-721-002	1650	0.72	106	3	17
20x25x4	19-3/8 x 24-3/8 x 3-3/4	120-721-003	1750	0.72	111	3	18
20x20x4	19-3/8 x 19-3/8 x 3-3/4	120-721-004	1100	0.72	88	3	13
18x24x4	17-3/8 x 23-3/8 x 3-3/4	120-721-005	1400	0.72	95	3	13
16x25x4	15-3/8 x 24-3/8 x 3-3/4	120-721-006	1400	0.72	88	3	13
16x24x4	15-3/8 x 23-3/8 x 3-3/4	120-721-019	1350	0.72	80	3	13
16x20x4	15-3/8 x 19-3/8 x 3-3/4	120-721-007	1125	0.72	70	3	11
12x24x4	11-3/8 x 23-3/8 x 3-3/4	120-721-008	1750	0.72	63	6	20

Standard Construction:

1. Gradient Density Microfiberglass Media
2. Hotmelt Adhesive Media Separators
3. Galvanized Steel Frame with 13/16" Header
4. Faceguard on Downstream Side (not shown)

Specifications:

1. Efficiency: MERV 13 (ASHRAE Standard 52.2-2017)
2. Final Resistance: 1.5" W.G.
3. Rated Velocity: 500 FPM
4. Classified per UL Standard 900
5. Maximum Operating Temperature: 150 F (66 C)
6. Tolerance: Height & Width - +/- 1/8"
7. Tolerance: Depth - +/- 1/16"

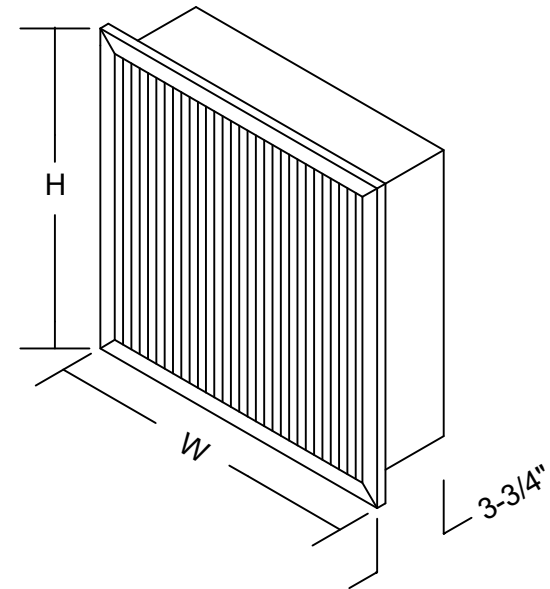

**MicroMAX
FM
MERV 13**

REV
LTR

REVISION

BY /
DATE

A

Size -002 & -003 Reversed

11/09/23

8401 Air Commerce Drive - Louisville KY 40219
Phone: (502) 634-4796 FAX: (502) 637-2280

Drawn By: Brent Chamberlain
Date: May 22, 2023

Revision
A